

TRI-FLO INC.

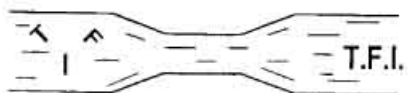

3410 E. 14th Street
 Los Angeles, CA 90023
 WEBSITE: www.triflotech.com

TEL: (323) 269-7700
 FAX: (323) 269-7707
 E. MAIL: sales@triflotech.com

ORIFICE PLATES



METER RUNS & FITTING FABRICATION AND SMALL HONED METER RUNS

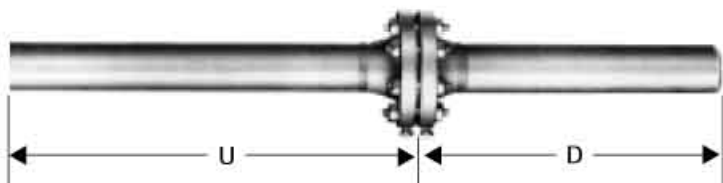

ORIFICE FLANGE UNIONS

DESIGNED AND MANUFACTURED
 TO AGA AND ASME AND ISA RECOMMENDATIONS

VENTURI TUBES

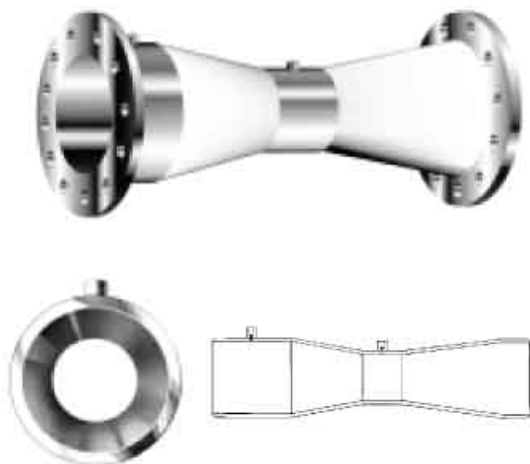

FLOW NOZZLES

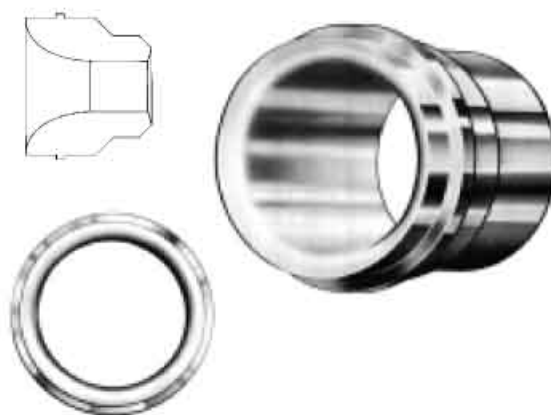

CUSTOM CRAFTED
 FLOW ELEMENTS



TRI-FLO INC.



Concentric



Eccentric



Segmental

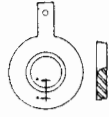

Quadrant Edge



Standards:

ISA
AGA
ASME
ISO

Materials:

304 & 316SS
Monel
Hastelloy C&B
Alloy 20
Teflon
Titanium
Tantalum

Grounding Rings

Ring Joint Orifice Plate Holders



Spacers

Materials: Carbon Steel
Stainless Steel
Alloy Steel
PVC
Bronze

Orifice Flange Unions

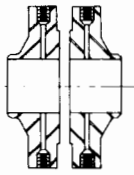

Weld Neck

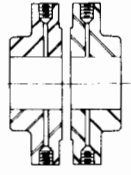

Slip On

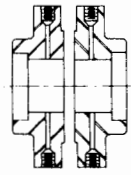

Socket Weld

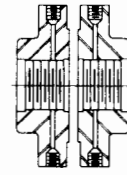

Threaded

Orifice Flange Union Meter Runs

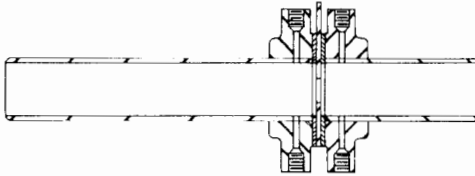

Size, Length, Flange Rating, Configuration and Outer Ends to Fit Application

Honed Meter Runs

VENTURI TUBES



Weld In

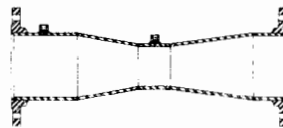

Flanged

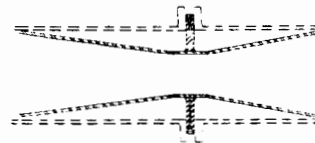

Insert

Available in almost any material that can be welded, fabricated, machined, cast or molded.

New Modern plant and equipment + computer system for fast, accurate calculations and designs + experienced personnel + state of the art construction methods =

RAPID DELIVERY AT COMPETITIVE PRICES

CUSTOM CRAFTED
FLOW ELEMENTS



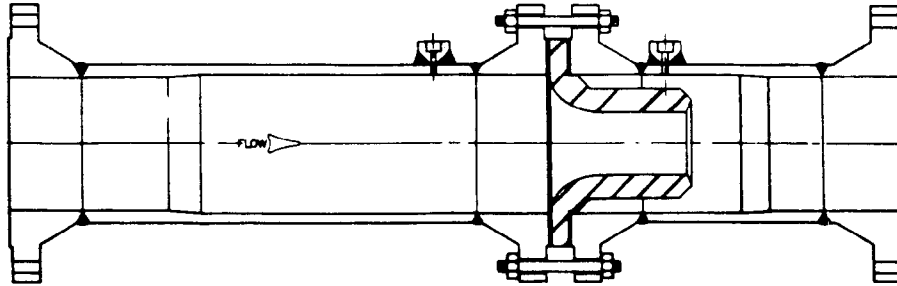

METER RUN BUILT TO ASME RECOMMENDATIONS

Flow Nozzles

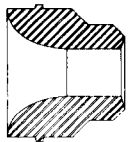

Weld In



Flanged

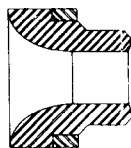

Holding Ring



Throat Tap

Long Radius Type
ASME-ISO

Materials: Carbon Steel, Stainless Steel
Chrome-Moly, Inconel, Fiberglass

Flow Nozzle Meter Runs



Available to fit all types of flow
nozzles and installations

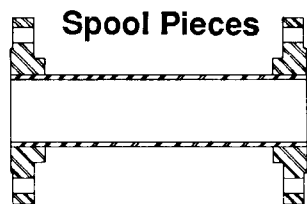

Spool Pieces

Size, Flange Rating
Length to fit requirements

Straightening Vanes

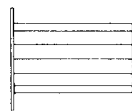
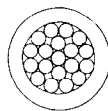

Flanged and
Line Types

Condensate Chambers



Size, Material
and Pressure
Rating as
Required

Restriction Orifice Unions



All Sizes, Ratings
Available

WE WILL BUILD
TO YOUR DESIGN

OR

WE WILL DESIGN AND
BUILD FOR YOU

SPECIAL FLOW DEVICES

We will make recommendations where cost savings, increased efficiency or reduced maintenance would result.

LET US QUOTE TO YOUR REQUIREMENTS

CUSTOM CRAFTED
FLOW ELEMENTS



INTEGRAL FLOW ORIFICE ASSEMBLIES

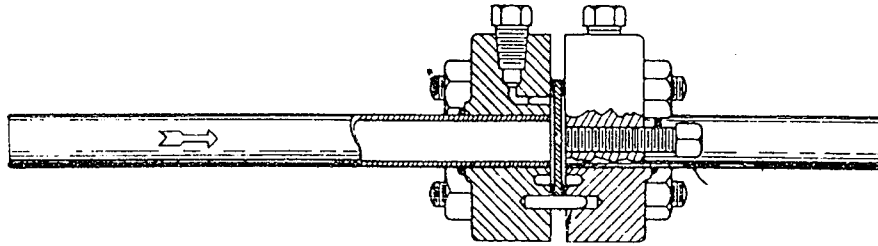

Used in combination with pneumatic or electronic
d/p cell, for accurate measurement
1/2 in., 1 in., 1 1/2 in. sizes in
304SS, 316SS, HAST "C", MONEL, PVC, CPVC, ETC.

VENTURI TUBES

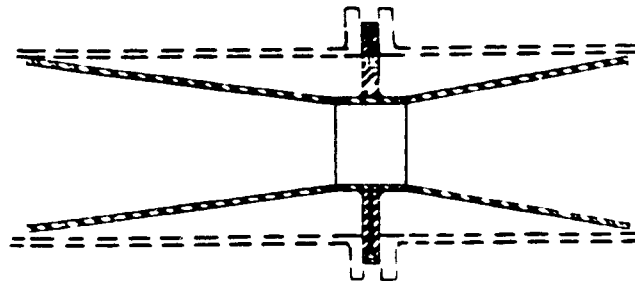

Insert

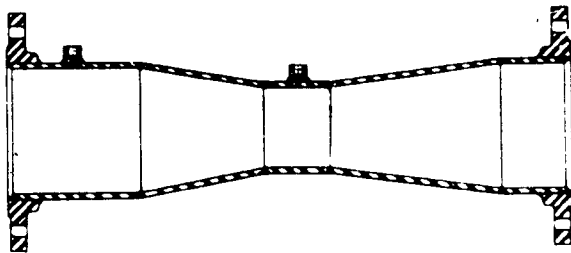

Flanged

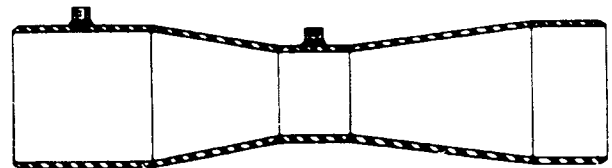

Weld In

New Modern plant and equipment + computer system for fast, accurate calculations
and designs + experienced personnel + state of the art construction methods =

RAPID DELIVERY AT COMPETITIVE PRICES

CUSTOM CRAFTED
FLOW ELEMENTS

